

DORN  
BRACHT

Dornbracht  
CL.1

Sharpen  
your  
senses



Culturing Life



EN

Our senses get it before we understand.  
Warm or cold? Hard or soft?  
Smooth or rough? Real or digital?

We connect with the world ever  
more quickly but yearn for real things  
ever more frequently – materials,  
textures, surfaces, shapes, colours, etc.

Interacting with these elements  
sharpens our senses and continually  
surprises us with new ways of  
designing our lives in the bathroom.



4

5





IT

I nostri sensi recepiscono prima di noi.  
Caldo o freddo? Duro o morbido?  
Levigato o ruvido? Reale o digitale?

Ci colleghiamo in rete con il mondo  
in modo sempre più rapido,  
ma sempre più spesso proviamo  
nostalgia per le cose naturali:  
materiali, tessuti, superfici, forme,  
colori...

L'interazione con questi elementi  
acuisce i nostri sensi – e ogni volta  
stupisce con nuove possibilità  
per organizzare la nostra vita in bagno.











ES

Nuestros sentidos captan las cosas antes de que las comprendamos. ¿Caliente o frío? ¿Duro o blando? ¿Liso o rugoso? ¿Real o digital?

Hoy en día nos podemos interconectar cada vez más deprisa con el mundo, pero anhelamos también con mayor frecuencia lo auténtico: materiales, texturas, superficies, formas, colores...

El juego con estos elementos agudiza nuestros sentidos y nos sorprende continuamente con nuevas posibilidades de configurar nuestra vida en el baño.





















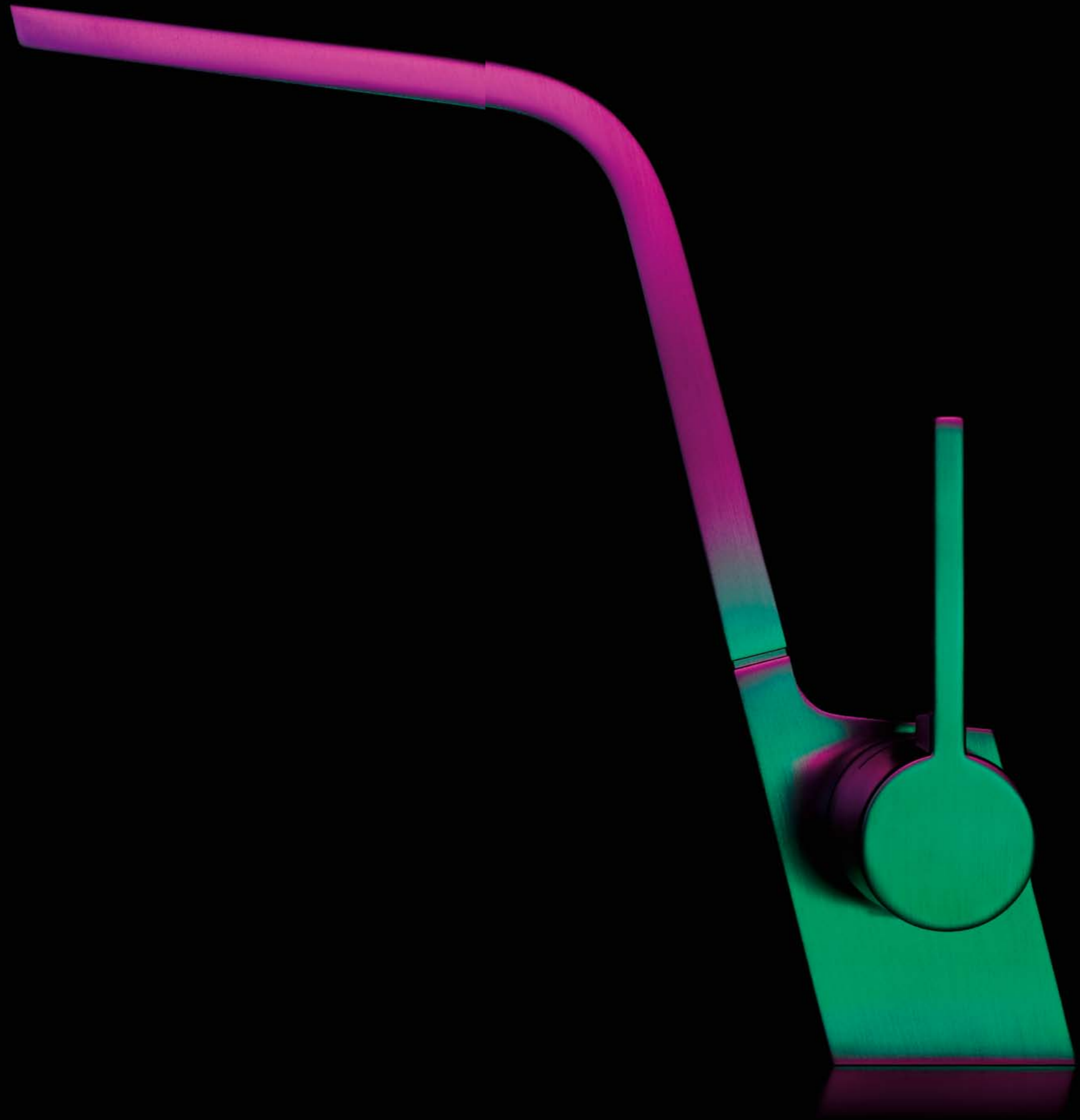



## CL.1

---

Dynamic,  
elegant,  
progressive,  
sporty.  
A fitting  
design that  
is like  
jumping into  
a new age.

EN CL.1 is character-  
ised by a delicate  
design language -  
a design which con-  
sistently combines  
hard and soft con-  
tours and reaches  
elegantly upwards.

IT CL.1 si contraddi-  
stingue per una  
forma filigranata:  
un design che combi-  
na costantemente tra  
loro profili marcati  
e morbidi e si pro-  
ietta elegantemente  
verso l'alto.

ES CL.1 se distingue  
por su lenguaje for-  
mal de filigrana: un  
diseño que combina,  
de forma consecuen-  
te, contornos duros  
y suaves, y que se  
extiende con elegan-  
cia hacia arriba.

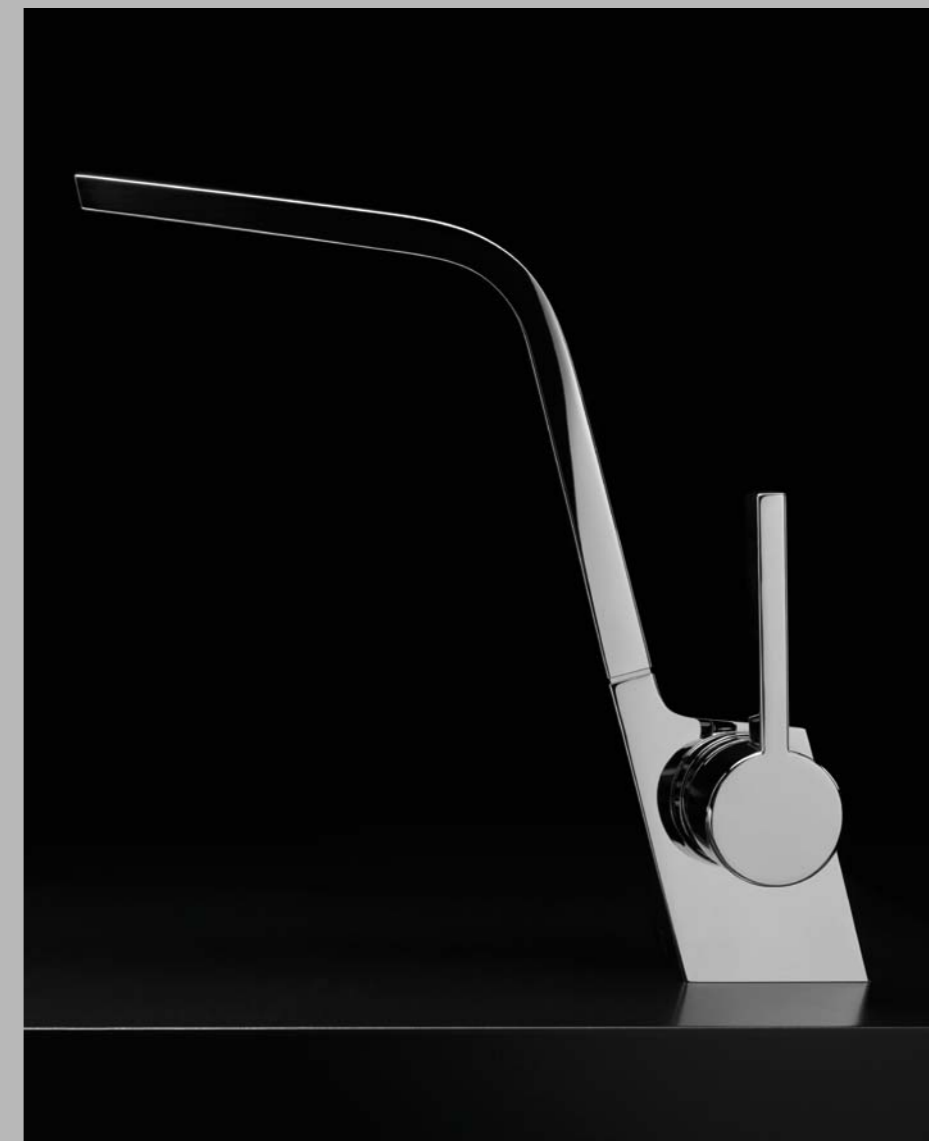

EN Straight lines and surfaces, defined contours, divine proportion - everything is perfectly coordinated with harmonious sizing.

IT Linee rette e superfici lineari, raggi definiti, rapporto aureo: tutto in perfetto accordo e proporzionato in modo armonico.

ES Líneas y superficies rectas, radios definidos, proporción áurea: todo está perfectamente equilibrado y armoniosamente proporcionado.



42

EN The characteristic feature of CL.1 is the conical spout which stretches upwards and the precise gap between the base and the fitting body.

IT Le caratteristiche di CL.1 sono la bocca di erogazione conica che si estende verso l'alto e la dimensione precisa dell'intaglio tra base e corpo della rubinetteria.

ES Las características del modelo CL.1 son el caño cónico que se extiende hacia arriba y el espacio preciso entre el zócalo y el cuerpo de la grifería.



43

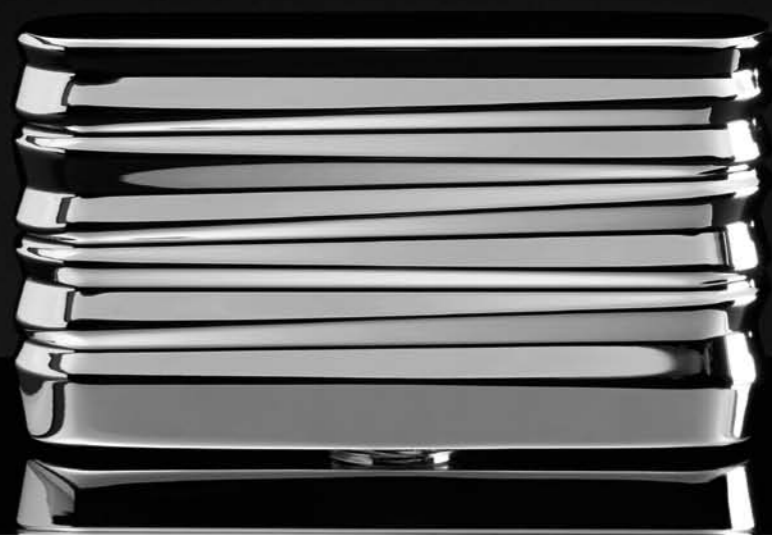
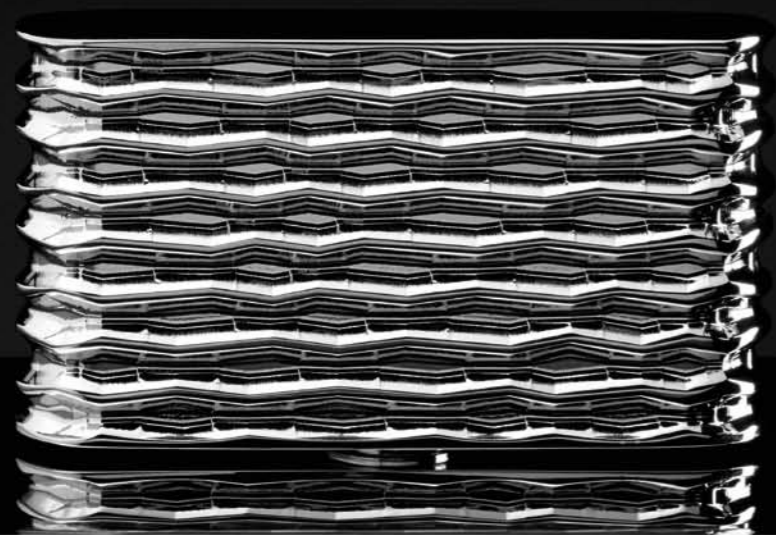

44

45



EN The new three-dimensional handle structures give the design a unique character. In addition to the classic smooth handle, they are available in chrome and platinum matt finishes and lend a haptic feel due to the precision of their workmanship.

IT Le nuove superfici tridimensionali delle manopole conferiscono al design un carattere inconfondibile. Sono disponibili - oltre che nella versione classica e liscia - con superfici in cromo e platino opaco e trasmettono un senso di precisione nella loro lavorazione che risulta percettibile al tatto.

ES Las nuevas estructuras de mando tridimensionales otorgan a este diseño su inconfundible carácter. Además del clásico mando liso, se ofrecen las versiones con acabados en cromo y platino mate, que transmiten una sensación háptica de la precisión de su acabado.





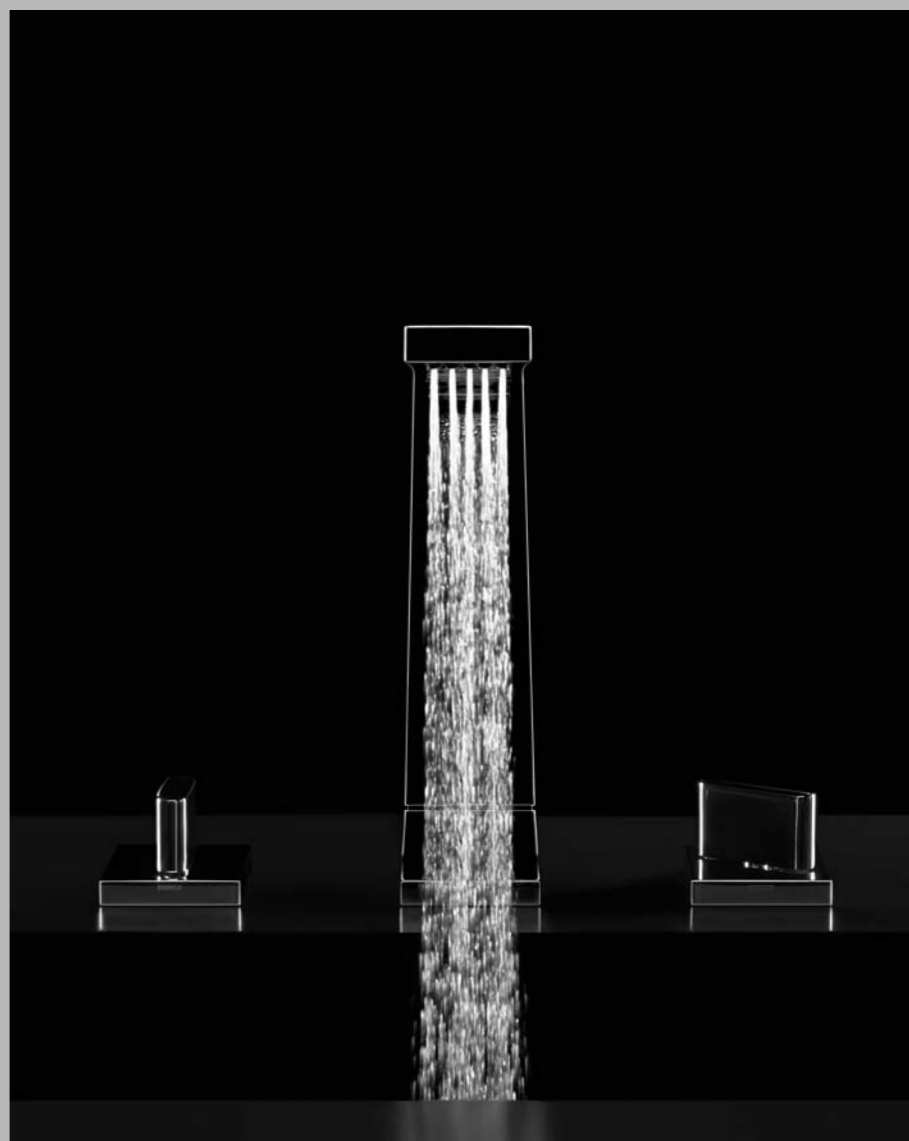

EN A new, unique jet type. 40 soft single jets rinse your hands particularly gently at the washstand. The specially developed spray face features low spray properties and low water consumption.

IT Un nuovo tipo di getto, unico nel suo genere: sul lavabo 40 singoli getti morbidi bagnano le mani in modo molto delicato. La superficie erogante, studiata appositamente, si contraddistingue per un getto leggero e un consumo d'acqua limitato.

ES Un tipo de chorro nuevo y único: en el lavabo, 40 suaves chorros individuales envuelven las manos con una especial delicadeza. El spray face, desarrollado específicamente para esta aplicación, reduce las salpicaduras y el consumo de agua.



EN Quality workmanship and precision down to the very last detail - like all fittings from Dornbracht, CL.1 is 100 % made in Germany. High quality galvanised finishes like chrome and platinum matt are the result of top quality standards and lengthy experience.

IT Qualità della lavorazione e precisione fin nel minimo dettaglio: come tutte le rubinetterie Dornbracht, anche CL.1 è realizzata al 100 % in Germania. Pregiate superfici galvaniche in cromo e platino opaco sono il risultato di standard qualitativi ai massimi livelli e di un'esperienza pluriennale.

ES Calidad artesanal y precisión hasta el último detalle: al igual que todas las griferías Dornbracht, también CL.1 está fabricada al 100 % en Alemania. Los acabados galvanicos de alta calidad, tales como cromo y platino mate, son el resultado de nuestros elevados estándares de calidad y de nuestra dilatada experiencia.



# Product Information

## Informazioni sui prodotti

## Información de producto

Excerpt from the product range.  
More detailed information can be obtained  
from your dealer.

Estratto dalla gamma completa prodotti.  
Il Vostro rivenditore specializzato sarà lieto  
di fornirvi maggiori informazioni.

Extracto del programa de productos.  
Su comercio le facilitará informaciones exhaustivas.

[x l/min. / x gpm]

indicates the maximum flow rate at 3 bar.

indica la portata massima a 3 bar.

representa el caudal máximo a 3 bar.

Finishes  
Superfici  
Superficies



00  
polished chrome  
cromato  
cromo

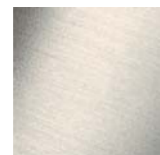

06  
platinum matt  
platinato opaco  
platino mate

Due to the printing technique used here,  
the colours shown above may vary from the  
true colour of the actual finish.

Per motivi tecnici di stampa non possiamo  
garantire la fedeltà dei colori qui riprodotti.

Los colores reproducidos en el presente  
catálogo no son vinculantes por razones de  
impresión.

## Basin

## Lavabo

## Lavabo

There is no end of possibilities when  
it comes to designing your own  
individual washstand – by freely  
combining outlet points, control  
elements and surface finishes. The  
new handle versions – with or without  
surface structure – offer even more  
design freedom.

Dalla libera combinazione di punti di  
erogazione, elementi di comando  
e superfici scaturiscono molteplici  
possibilità di allestire il lavabo in modo  
personalizzato. La libertà di allestimento  
si amplia maggiormente con le nuove  
varianti delle manopole – con o senza  
struttura delle superfici.

De la libre combinación de puntos de  
salida de agua, elementos de control y  
superficies surge una multitud de  
posibilidades para configurar el lavabo  
de forma individual. La libertad de  
diseño aumenta también gracias a las  
nuevas variantes de mandos, ya sea  
con estructura de superficie o sin ella.

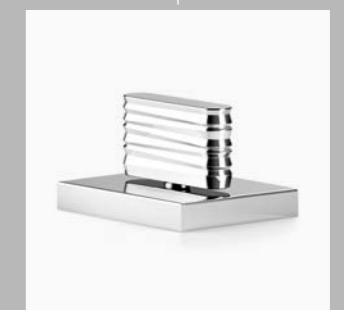



13 714 705 + 20 004 705 + 20 004 706

Three-hole basin mixer, 180 mm projection  
Batteria tre fori lavabo, sporgenza 180 mm  
Bateria americana de lavabo, saliente 180 mm

[4 l/min.]  
[USA: 3.9 l/min / 1.06 gpm]



13 715 705 + 20 004 705 + 20 004 706

Three-hole basin mixer, 190 mm projection  
Batteria tre fori lavabo, sporgenza 190 mm  
Bateria americana de lavabo, saliente 190 mm

[4 l/min.]  
[USA: 3.9 l/min / 1.06 gpm]



27 720 972 / 27 720 971 / 27 720 973

Deck-mounted spout with extending spray, with angular/round rosette or without rosette, 200 mm projection  
Bocca lavabo con doccetta estraibile, con rosette quadrate/rotonde o senza rosette, sporgenza 200 mm  
Caño de lavabo con grifo extraíble, con roseta cuadrada/redonda o sin roseta, saliente 200 mm

[5 l/min.]  
[USA: 5 l/min / 1.3 gpm]



27 728 972 / 27 728 971 / 27 728 973

Affusion pipe, with angular/round rosette or without rosette, 220 mm projection  
Doccetta per la cura personale, con rosette quadrate/rotonde o senza rosette, sporgenza 220 mm  
Ducha para cuidado personal, con roseta cuadrada/redonda o sin roseta, saliente 220 mm

[9,5 l/min.]  
[USA: 9.5 l/min / 2.5 gpm]



13 717 705 + 20 004 705 + 20 004 706

Three-hole basin mixer, 200 mm projection  
Batteria tre fori lavabo, sporgenza 200 mm  
Bateria americana de lavabo, saliente 200 mm

[4 l/min.]  
[USA: 3.9 l/min / 1.06 gpm]



33 521 705

Single-lever basin mixer without pop-up waste, 180 mm projection  
Miscelatore monocomando lavabo senza piletta, sporgenza 180 mm  
Monomando de lavabo sin válvula automática, saliente 180 mm

[4 l/min.]  
[USA: 3.9 l/min / 1.06 gpm]



27 750 972 / 27 750 971 / 27 750 973

Deck-mounted spout with rotating tip, with angular/round rosette or without rosette, 200 mm projection  
Bocca lavabo con elemento terminale girevole, con rosette quadrate/rotonde o senza rosette, sporgenza 200 mm  
Caño de lavabo con elemento final giratorio, con roseta cuadrada/redonda o sin roseta, saliente 200 mm

[5 l/min.]  
[USA: 5 l/min / 1.3 gpm]



27 755 972 / 27 755 971 / 27 755 973

Deck-mounted spout with rotating tip, with angular/round rosette or without rosette, 200 mm projection  
Bocca lavabo con elemento terminale girevole, con rosette quadrate/rotonde o senza rosette, sporgenza 200 mm  
Caño de lavabo con elemento final giratorio, con roseta cuadrada/redonda o sin roseta, saliente 200 mm

[5 l/min.]  
[USA: 5 l/min / 1.3 gpm]



36 812 705

Wall-mounted single-lever basin mixer, 200 mm projection  
Miscelatore monocomando lavabo incasso, sporgenza 200 mm  
Bateria monomando empotrada para lavabo, saliente 200 mm

[4 l/min.]  
[USA: 3.9 l/min / 1.06 gpm]



13 800 705 + 36 310 706 + 36 310 707

Wall-mounted basin mixer, 200 mm projection  
Tre fori incasso a muro, sporgenza 200 mm  
Bateria de pared para lavabo, saliente 200 mm

[4 l/min.]  
[USA: 3.9 l/min / 1.06 gpm]



20 004 705 / 20 004 706

Deck valve clockwise closing, cold/anti-clockwise closing, hot  
Rubinetto laterale con chiusura a destra, fredda/sinistra, calda  
Válvula lateral cierre a derecha, fría/cierre a izquierda, caliente

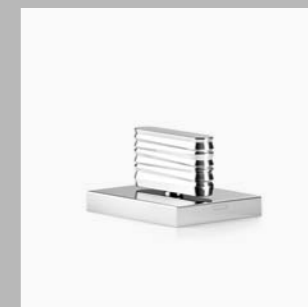

20 005 705 / 20 005 706

Deck valve clockwise closing, cold/anti-clockwise closing, hot with structure  
Rubinetto laterale con chiusura a destra per la fredda/sinistra per la calda con superficie in rilievo  
Válvula lateral cierre a derecha, fría/cierre a izquierda, caliente con relieve



13 714 705

Deck-mounted basin spout without pop-up waste, 180 mm projection  
Bocca verticale lavabo senza piletta, sporgenza 180 mm  
Salida vertical para lavabo sin válvula automática, saliente 180 mm

[4 l/min.]  
[USA: 3.9 l/min / 1.06 gpm]



13 715 705

Deck-mounted basin spout without pop-up waste, 190 mm projection  
Bocca verticale lavabo senza piletta, sporgenza 190 mm  
Salida vertical para lavabo sin válvula automática, saliente 190 mm

[4 l/min.]  
[USA: 3.9 l/min / 1.06 gpm]

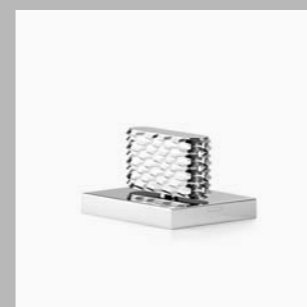

20 006 705 / 20 006 706

Deck valve clockwise closing, cold/anti-clockwise closing, hot with structure  
Rubinetto laterale con chiusura a destra per la fredda/sinistra per la calda con superficie in rilievo  
Válvula lateral cierre a derecha, fría/cierre a izquierda, caliente con relieve



20 000 740 / 20 000 741

Deck valve clockwise closing, cold/anti-clockwise closing, hot  
Rubinetto laterale con chiusura a destra, fredda/sinistra, calda  
Válvula lateral cierre a derecha, fría/cierre a izquierda, caliente



13 717 705

Deck-mounted basin spout without pop-up waste, 200 mm projection  
Bocca verticale lavabo senza piletta, sporgenza 200 mm  
Salida vertical para lavabo sin válvula automática, saliente 200 mm

[4 l/min.]  
[USA: 3.9 l/min / 1.06 gpm]



13 800 705

Wall-mounted basin spout, 200 mm projection  
Bocca lavabo incasso, sporgenza 200 mm  
Salida a pared de lavabo, saliente 200 mm

[4 l/min.]  
[USA: 3.9 l/min / 1.06 gpm]



29 125 705

Two-way diverter  
Deviatore a due vie  
Inversor de dos vías

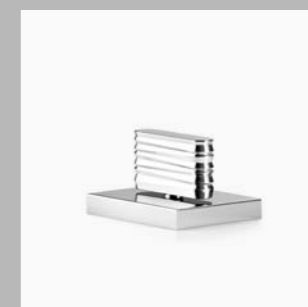

29 121 705

Two-way diverter with structure  
Deviatore a due vie con superficie in rilievo  
Inversor de dos vías con relieve



29 122 705

Two-way diverter with structure  
Deviatore a due vie con superficie in rilievo  
Inversor de dos vías con relieve



29 126 740

Two-way diverter  
Deviatore a due vie  
Inversor de dos vías



36 310 706 / 36 310 707

Wall valve clockwise closing/anti-clockwise closing  
Rubinetto incasso con chiusura a destra/con chiusura a sinistra  
Llave de paso cierre a derecha/cierre a izquierda

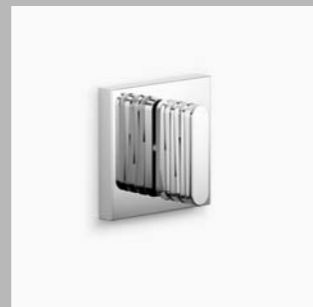

36 311 706 / 36 311 707

Wall valve clockwise closing/anti-clockwise closing with structure  
Rubinetto incasso con chiusura a destra/con chiusura a sinistra con superficie in rilievo  
Llave de paso cierre a derecha/cierre a izquierda con relieve



36 312 706 / 36 312 707

Wall valve clockwise closing/anti-clockwise closing with structure  
Rubinetto incasso con chiusura a destra/con chiusura a sinistra con superficie in rilievo  
Llave de paso cierre a derecha/cierre a izquierda con relieve

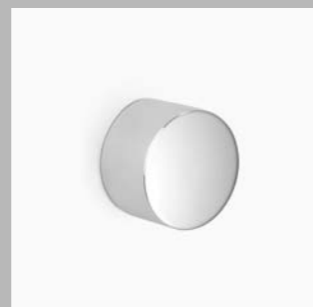

36 311 740 / 36 311 741

Wall valve clockwise closing/anti-clockwise closing  
Rubinetto incasso con chiusura a destra/con chiusura a sinistra  
Llave de paso cierre a derecha/cierre a izquierda



42 760 979

SMART TOOLS electronic control elements  
SMART TOOLS elementi di comando elettronici  
SMART TOOLS elementos de manejo electrónicos

## Bidet



33 600 705

Single-lever bidet mixer  
Miscelatore monocomando bidet  
Monomando bidet  
[7 l/min.]  
[USA: 7 l/min / 1.85 gpm]

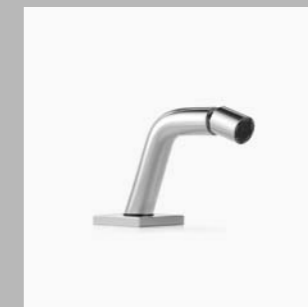

13 900 972

Deck-mounted bidet spout  
Bocca bidet  
Caño de bidet  
[5 l/min.]  
[USA: 5 l/min / 1.3 gpm]



20 004 705 / 20 004 706

Deck valve clockwise closing, cold/anti-clockwise closing, hot  
Rubinetto laterale con chiusura a destra, fredda/sinistra, calda  
Válvula lateral cierre a derecha, fría/cierre a izquierda, caliente

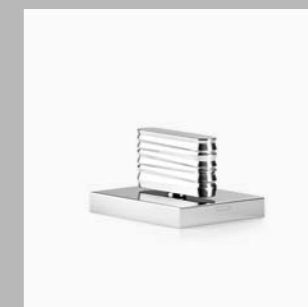

20 005 705 / 20 005 706

Deck valve clockwise closing, cold/anti-clockwise closing, hot with structure  
Rubinetto laterale con chiusura a destra per la fredda/sinistra per la calda con superficie in rilievo  
Válvula lateral cierre a derecha, fría/cierre a izquierda, caliente con relieve



20 006 705 / 20 006 706

Deck valve clockwise closing, cold/anti-clockwise closing, hot with structure  
Rubinetto laterale con chiusura a destra per la fredda/sinistra per la calda con superficie in rilievo  
Válvula lateral cierre a derecha, fría/cierre a izquierda, caliente con relieve



20 000 740 / 20 000 741

Deck valve clockwise closing, cold/anti-clockwise closing, hot  
Rubinetto laterale con chiusura a destra, fredda/sinistra, calda  
Válvula lateral cierre a derecha, fría/cierre a izquierda, caliente



36 310 706 / 36 310 707

Wall valve clockwise closing/anti-clockwise closing  
Rubinetto incasso con chiusura a destra/con chiusura a sinistra  
Llave de paso cierre a derecha/cierre a izquierda

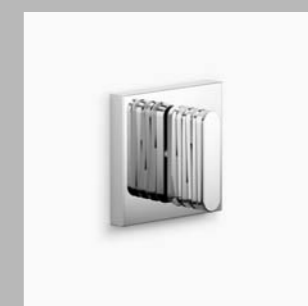

36 311 706 / 36 311 707

Wall valve clockwise closing/anti-clockwise closing with structure  
Rubinetto incasso con chiusura a destra/con chiusura a sinistra con superficie in rilievo  
Llave de paso cierre a derecha/cierre a izquierda con relieve



36 312 706 / 36 312 707  
 Wall valve clockwise closing/  
 anti-clockwise closing with structure  
 Rubinetto incasso con chiusura a  
 destra/con chiusura a sinistra con  
 superficie in rilievo  
 Llave de paso cierre a derecha/  
 cierre a izquierda con relieve

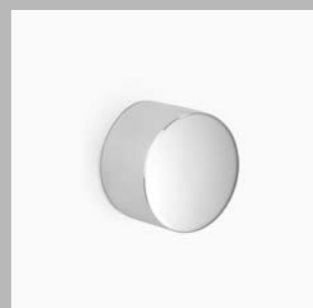

36 311 740 / 36 311 741  
 Wall valve clockwise closing/  
 anti-clockwise closing  
 Rubinetto incasso con chiusura a  
 destra/con chiusura a sinistra  
 Llave de paso cierre a derecha/  
 cierre a izquierda

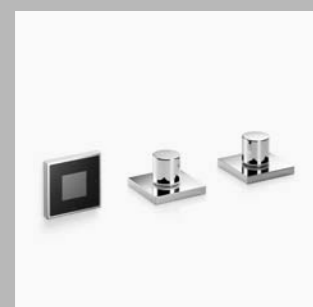

42 760 979  
 SMART TOOLS electronic  
 control elements  
 SMART TOOLS elementi  
 di comando elettronici  
 SMART TOOLS elementos  
 de manejo electrónicos

## Shower Doccia Ducha

Head spray or rain shower? Chrome or platinum matt? Mechanical or digital? There are many ways to arrange the shower area. A selection of different options for the control elements is also available. The new structured handles are shown to good advantage when used together with the xTOOL.

Getto doccia testa o soffione a pioggia? Cromo o platino opaco? Meccanica o digitale? Ci sono molte possibilità per allestire l'area doccia. E anche tra gli elementi di comando si ha la scelta tra varie opzioni. Le nuove manopole strutturate si fanno ben valere combinate con l'xTOOL.

¿Ducha de cabeza o de lluvia? ¿En cromo o en platino mate? ¿Mecánica o digital? Hay muchas maneras de diseñar el área de la ducha. También hay diferentes opciones disponibles en cuanto a los elementos de control. Los nuevos mandos de estructura destacan especialmente en combinación con el xTOOL.

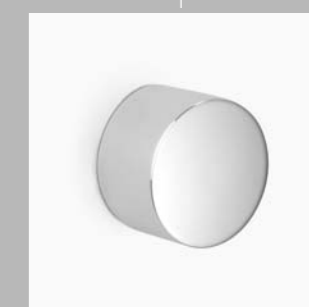
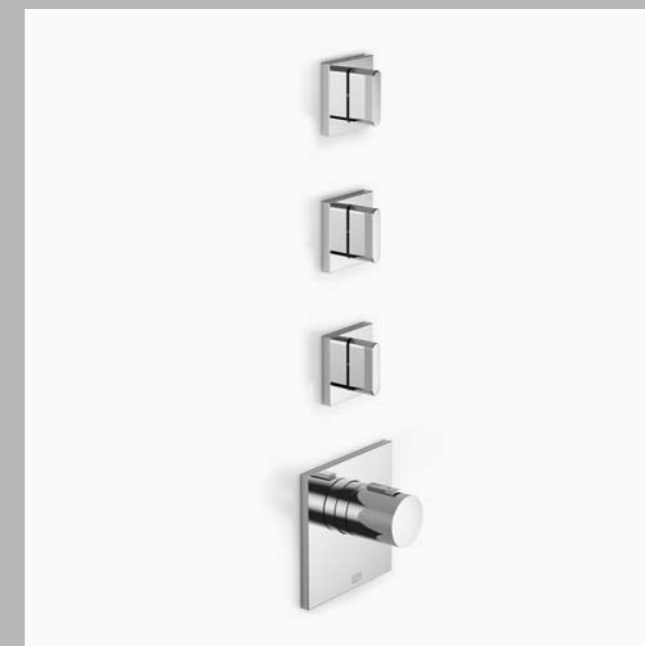



36 010 705 \*\*  
 Wall-mounted single-lever shower mixer with shower set  
 Miscelatore monocomando incasso con doccetta, flessibile e asta saliscendi  
 Batería monomando empotrada para ducha con ducha de mano y barra  
 [7,6 l/min.]



28 755 980 \* / 28 755 979  
 Shower to fix under the ceiling, 300 x 240 mm  
 Soffione a pioggia con fissaggio a soffitto, 300 x 240 mm  
 Ducha de lluvia con fijación a plafón, 300 x 240 mm  
 [14 l/min.]  
 [USA: 7.6 l/min / 2 gpm]



28 518 782 \* / 28 519 782 \*  
 Body spray without/with volume control  
 Soffione laterale senza/con regolazione di portata dell'acqua  
 Ducha lateral de masaje articulada sin/con regulación de caudal  
 [5/8 l/min.]  
 [USA: 5/8 l/min / 1.3/2 gpm]



26 402 980 \*  
 Complete shower set  
 Gruppo doccetta con flessibile e asta saliscendi  
 Juego de ducha de mano con barra corredera  
 [7,6 l/min.]  
 [USA: 7.6 l/min / 2 gpm]



28 745 980 \* / 28 745 979  
 Shower with wall fixing, 300 x 240 mm  
 Soffione a pioggia con fissaggio a muro, 300 x 240 mm  
 Ducha de lluvia con fijación a pared, 300 x 240 mm  
 [14 l/min.]  
 [USA: 7.6 l/min / 2 gpm]

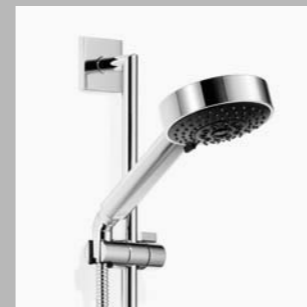

26 403 980 \*  
 Complete shower set  
 Gruppo doccetta con flessibile e asta saliscendi  
 Juego de ducha de mano con barra corredera  
 [9 l/min.]  
 [USA: 7.6 l/min / 2 gpm]

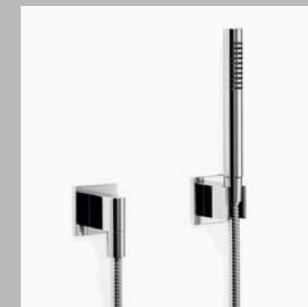

27 808 980 \*  
 Complete hand shower set  
 Gruppo doccetta con flessibile a muro  
 Juego de ducha de mano con codo de conexión a pared  
 [7,6 l/min.]  
 [USA: 7.6 l/min / 2 gpm]



13 415 979  
 WATER SHEET 1/2" wall-mounted cascade spout  
 WATER SHEET bocca di erogazione a getto per montaggio a muro 1/2"  
 WATER SHEET salida en chorro para montaje a pared 1/2"  
 [26,5 l/min.]  
 [USA: 26.5 l/min / 7 gpm]



13 420 979 \*  
 WATER FALL 1/2" wall-mounted waterfall  
 WATER FALL bocca di erogazione a cascata per montaggio a muro 1/2"  
 Caño de salida en cascada WATER FALL para montaje en pared, 1/2"  
 [26,5 l/min.]  
 [USA: 9.5 l/min / 2.5 gpm]

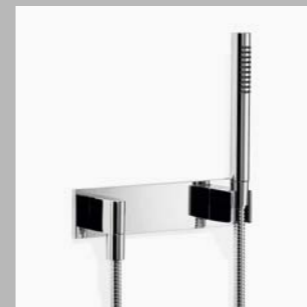

27 818 980 \* / 27 818 979  
 Complete hand shower set  
 Gruppo doccetta con flessibile a muro  
 Juego de ducha de mano con codo de conexión a pared  
 [7,6 l/min.]  
 [USA: 7.6 l/min / 2 gpm]



27 838 979  
 Affusion pipe with cover plate  
 Doccetta per la cura personale con piastra di copertura  
 Ducha para cuidado personal con cubierta  
 [9,5 l/min.]  
 [USA: 9.5 l/min / 2.5 gpm]



13 425 979  
 WATER FALL with PEARLSTREAM for wall-mounting 1/2"  
 WATER FALL con PEARLSTREAM per montaggio a muro 1/2"  
 WATER FALL con PEARLSTREAM para montaje en pared 1/2"  
 [26,5 l/min.]  
 [USA: 9.5 l/min / 2.5 gpm]



36 517 979  
 WATER BAR concealed body spray  
 WATER BAR soffione laterale incasso  
 WATER BAR ducha lateral empotrada  
 [6,5 l/min.]  
 [USA: 6.5 l/min / 1.7 gpm]



36 416 780 + 3x 36 310 705 / + 2x 36 310 705 / + 1x 36 310 705  
 xTOOL thermostat module with 3 valves/2 valves/1 valve  
 xTOOL modulo termostato con 3 rubinetti/2 rubinetti/1 rubinetto  
 Módulo de termostato xTOOL con 3 válvulas/2 válvulas/1 válvula

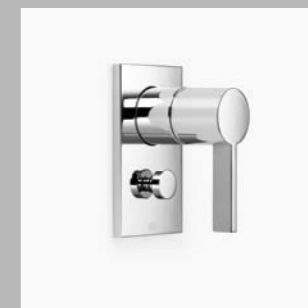

36 120 670 \*\*\* / 36 020 670 \*\*\*  
 Concealed single-lever mixer with/without diverter  
 Miscelatore monocomando incasso con/senza deviatore  
 Batería monomando empotrada con/sin inversor

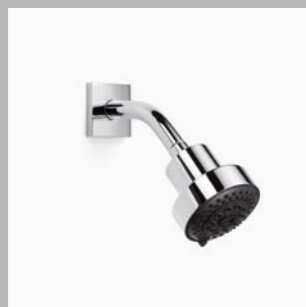

28 508 980 \*  
 Shower head with three settings  
 Doccia testa regolabile a tre getti  
 Ducha fija, ajustable en 3 modos  
 [9 l/min.]  
 [USA: 7.6 l/min / 2 gpm]

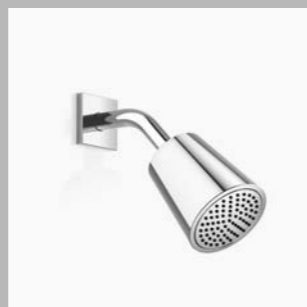

28 504 670 \*  
 Shower head  
 Doccia testa  
 Ducha fija  
 [7 l/min.]  
 [USA: 7 l/min / 1.85 gpm]



36 008 670 \*\*\*  
 Wall-mounted single-lever shower mixer  
 Miscelatore monocomando doccia incasso  
 Monomando empotrado para ducha

\* Mechanically controlled only. / Possibilità di comando solo meccanico. / Solo controlable mecánicamente. \*\* Not available in North America. / Non disponibile sul mercato nordamericano. / No disponible en Norteamérica.

\*\*\* Not available in North America. Alternatively, a concealed thermostate is available. / Non disponibile sul mercato nordamericano. In alternativa è disponibile un termostato ad incasso. / No disponible en Norteamérica. Como alternativa está disponible un termostato empotrado.



36 104 705  
Concealed two- and three-way diverter  
Deviatore a due/tre vie da incasso  
Inversor empotrado de dos/tres vías



36 101 705  
Concealed two- and three-way diverter with structure  
Deviatore a due/tre vie da incasso con superficie in rilievo  
Inversor empotrado de dos/tres vías con relieve



36 102 705  
Concealed two- and three-way diverter with structure  
Deviatore a due/tre vie da incasso con superficie in rilievo  
Inversor empotrado de dos/tres vías con relieve

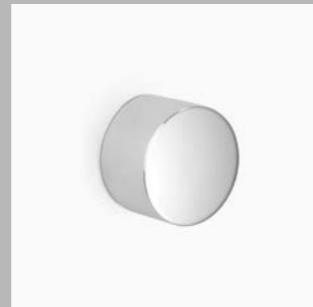

36 125 740  
Concealed two-way diverter  
Deviatore a due vie da incasso  
Inversor de dos vías empotrado



36 310 705  
Wall valve  
Rubinetto incasso  
Llave de paso

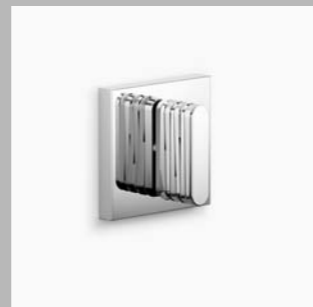

36 311 705  
Wall valve with structure  
Rubinetto incasso con superficie in rilievo  
Llave de paso con relieve

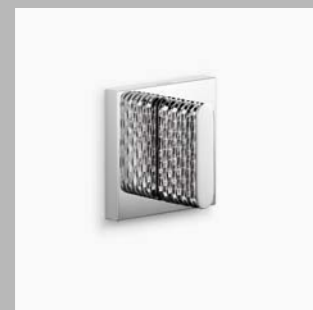

36 312 705  
Wall valve with structure  
Rubinetto incasso con superficie in rilievo  
Llave de paso con relieve

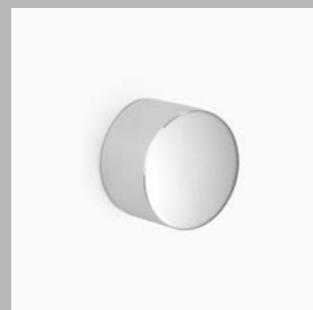

36 310 740  
Wall valve  
Rubinetto incasso  
Llave de paso

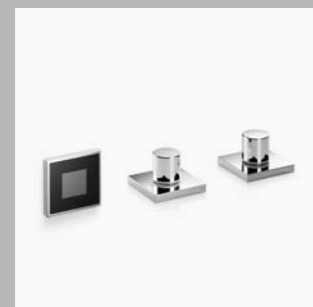

42 760 979  
SMART TOOLS electronic control elements  
SMART TOOLS elementi di comando elettronici  
SMART TOOLS elementos de manejo electrónicos

## Bath Vasca Bañera

The ways to arrange the bathtub area are as varied as your own requirements. Spouts for bath rim installation, deck mounting or wall mounting, various control options – everything can be adjusted to suit your own personal requirements as regards comfort and design. In addition, special accents can be created thanks to the new structured handles.

Le possibilità di allestimento dell'area vasca sono numerose tanto quanto i propri bisogni. Bocche di erogazione per il montaggio bordo vasca, verticale o a muro, svariate possibilità di comando – tutto si adatta ai desideri personali di comfort e forma. Con le nuove manopole strutturate, inoltre, si può davvero lasciare un segno.

Hay tantas posibilidades de diseño del área de la bañera como necesidades. Salidas de agua para el montaje a borde de bañera, en posición vertical o a pared, diversas posibilidades de control: todo se adapta a los deseos personales de confort y diseño. Con los nuevos mandos de estructura se pueden dar toques especiales.







27 702 980 + 20 000 706 +  
13 612 705 + 20 000 705 +  
29 126 705

Deck-mounted bath set with  
hand shower set

Gruppo vasca cinque fori per  
montaggio bordo vasca

Batería de bañera de cinco  
orificios para montaje a borde  
de bañera

[7,6 l/min.] \*\*  
[USA: 7.6 l/min / 2 gpm] \*\*



25 964 979 / 25 963 979

Single-lever bath mixer with  
cascade spout for free-standing  
assembly

Miscelatore monocomando vasca  
con bocca di erogazione a cascata  
per montaggio indipendente

Monomando de bañera con  
caño de salida en cascada para  
montaje aislado

[7,6 l/min.] \*\*  
[USA: 7.6 l/min / 2 gpm] \*\*



13 420 979

WATER FALL 1/2" wall-mounted  
waterfall

WATER FALL bocca di erogazione  
a cascata per montaggio a muro 1/2"

Caño de salida en cascada WATER  
FALL para montaje en pared, 1/2"

[26,5 l/min.]  
[USA: 9.5 l/min / 2.5 gpm]

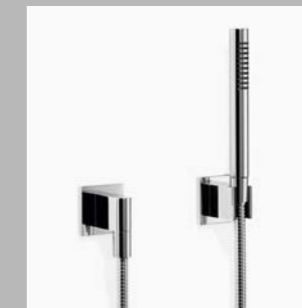

27 808 980

Complete hand shower set  
Gruppo doccetta con flessibile  
a muro

Juego de ducha de mano con  
codo de conexión a pared

[7,6 l/min.]  
[USA: 7.6 l/min / 2 gpm]



27 702 980 + 13 612 705 +  
29 126 705 + 29 200 670

Deck-mounted bath mixer with  
hand shower set

Gruppo vasca quattro fori con  
miscelatore monocomando per  
montaggio su bordo vasca

Batería monomando de cuatro  
orificios para montaje a borde  
de bañera

[7,6 l/min.] \*\*  
[USA: 7.6 l/min / 2 gpm] \*\*



13 801 705

1/2" wall-mounted bath spout

Bocca vasca montaggio  
a muro 1/2"

Caño de bañera a pared 1/2"

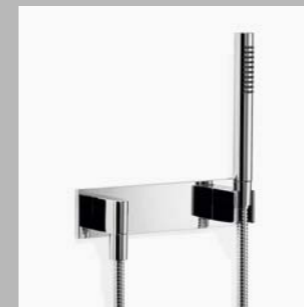

27 818 980 / 27 818 979

Complete hand shower set

Gruppo doccetta con flessibile  
a muro

Juego de ducha de mano con  
codo de conexión a pared

[7,6 l/min.]  
[USA: 7.6 l/min / 2 gpm]



36 115 782 \*\*\* / 36 015 782 \*\*\*

xSTREAM single-lever mixer for  
wall mounting with/without diverter

xSTREAM miscelatore monocomando  
per montaggio a incasso con/senza  
deviatore

Batería monomando xSTREAM  
con/sin inversor para montaje  
empotrado



13 612 705

Deck-mounted bath spout,  
200 mm projection

Bocca verticale vasca,  
sporgenza 200 mm

Salida vertical para bañera,  
saliente 200 mm



20 000 705 / 20 000 706

Deck valve clockwise closing,  
cold/anti-clockwise closing, hot

Rubinetto laterale con chiusura a  
destra, fredda/sinistra, calda

Válvula lateral cierre a derecha,  
fría/cierre a izquierda, caliente



20 001 705 / 20 001 706

Deck valve clockwise closing,  
cold/anti-clockwise closing, hot  
with structure

Rubinetto laterale con chiusura a  
destra per la fredda/sinistra per la  
calda con superficie in rilievo

Válvula lateral cierre a derecha,  
fría/cierre a izquierda, caliente  
con relieve



13 672 730 \*

Bath spout with stand pipe

Bocca vasca con tubo verticale

Caño de bañera con tubo vertical



27 702 980

Deck-mounted shower assembly

Gruppo doccetta con flessibile  
montaggio bordo vasca

Juego de manguera para ducha,  
montaje a borde de bañera

[7,6 l/min.]  
[USA: 7.6 l/min / 2 gpm]



20 002 705 / 20 002 706

Deck valve clockwise closing,  
cold/anti-clockwise closing, hot  
with structure

Rubinetto laterale con chiusura a  
destra per la fredda/sinistra per la  
calda con superficie in rilievo

Válvula lateral cierre a derecha,  
fría/cierre a izquierda, caliente  
con relieve



20 000 740 / 20 000 741

Deck valve clockwise closing,  
cold/anti-clockwise closing, hot

Rubinetto laterale con chiusura a  
destra, fredda/sinistra, calda

Válvula lateral cierre a derecha,  
fría/cierre a izquierda, caliente



13 415 979

WATER SHEET 1/2" wall-mounted  
cascade spout

WATER SHEET bocca di erogazione  
a getto per montaggio a muro 1/2"

WATER SHEET salida en chorro  
para montaje a pared 1/2"

[26,5 l/min.]  
[USA: 26.5 l/min / 7 gpm]



29 126 705

Two-way deck-mounted diverter

Deviatore a due vie bordo vasca

Inversor de dos vías para montaje  
a borde de bañera

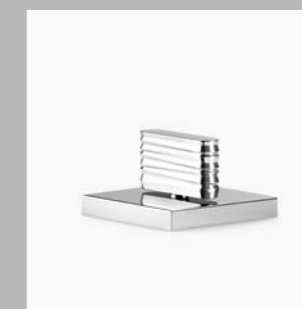

29 127 705

Two-way deck-mounted diverter  
with structure

Deviatore a due vie bordo vasca  
con superficie in rilievo

Inversor de dos vías para montaje  
a borde de bañera con relieve



29 128 705  
Two-way deck-mounted diverter with structure  
Deviatore a due vie bordo vasca con superficie in rilievo  
Inversor de dos vías para montaje a borde de bañera con relieve



29 126 740  
Two-way diverter  
Deviatore a due vie  
Inversor de dos vías



29 200 670  
Single-lever bath mixer for bath rim installation  
Miscelatore monocomando vasca per montaggio bordo vasca  
Monomando de bañera para montaje a borde de bañera



42 760 979  
SMART TOOLS electronic control elements  
SMART TOOLS elementi di comando elettronici  
SMART TOOLS elementos de manejo electrónicos



36 104 705  
Concealed two- and three-way diverter  
Deviatore a due/tre vie da incasso  
Inversor empotrado de dos/tres vías



36 101 705  
Concealed two- and three-way diverter with structure  
Deviatore a due/tre vie da incasso con superficie in rilievo  
Inversor empotrado de dos/tres vías con relieve

## Accessories Accessori Accesorios



36 102 705  
Concealed two- and three-way diverter with structure  
Deviatore a due/tre vie da incasso con superficie in rilievo  
Inversor empotrado de dos/tres vías con relieve

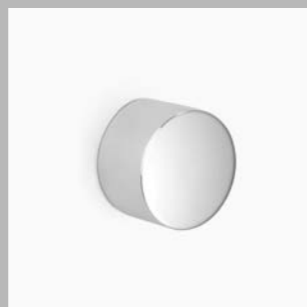

36 125 740  
Concealed two-way diverter  
Deviatore a due vie da incasso  
Inversor de dos vías empotrado



83 211 705  
1 arm towel bar, non-swivel  
Portasciugamani singolo, fisso  
Horquilla para toallas de mano, rígida



83 500 705  
Tissue holder without cover  
Portarotolo senza coprirotolo  
Portarrollos sin tapa



36 310 706 / 36 310 707  
Wall valve clockwise closing/anti-clockwise closing  
Rubinetto incasso con chiusura a destra/con chiusura a sinistra  
Llave de paso cierre a derecha/cierre a izquierda

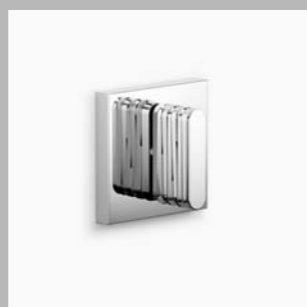

36 311 706 / 36 311 707  
Wall valve clockwise closing/anti-clockwise closing with structure  
Rubinetto incasso con chiusura a destra/con chiusura a sinistra con superficie in rilievo  
Llave de paso cierre a derecha/cierre a izquierda con relieve



83 020 705  
Bath grip, 210 mm  
Maniglia d'appoggio, 210 mm  
Barra para bañera, 210 mm



83 045 705 / 83 060 705  
Towel bar, 450/600 mm  
Asta portasciugamani, 450/600 mm  
Barra para toallas de baño, 450/600 mm



36 312 706 / 36 312 707  
Wall valve clockwise closing/anti-clockwise closing with structure  
Rubinetto incasso con chiusura a destra/con chiusura a sinistra con superficie in rilievo  
Llave de paso cierre a derecha/cierre a izquierda con relieve

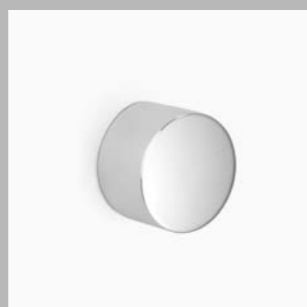

36 311 740 / 36 311 741  
Wall valve clockwise closing/anti-clockwise closing  
Rubinetto incasso con chiusura a destra/con chiusura a sinistra  
Llave de paso cierre a derecha/cierre a izquierda



83 410 840  
Soap dish wall model, complete  
Portasaponetta modello da parete, completo  
Jabonera modelo para colocar en la pared, completo



84 430 970 / 83 430 970  
Lotion dispenser free-standing/wall model, complete  
Dispenser per sapone modello da appoggio/da parete, completo  
Dosificador de loción completo, modelo de colocación independiente/de pared



82 438 972

Integrated lotion dispenser  
Dispenser per sapone incasso  
Dosificador de jabón líquido  
encastrable



83 400 840

Tumbler holder wall model,  
complete  
Portabicchiere modello da parete,  
completo  
Soporte para vaso modelo para  
colocar en la pared, completo



83 900 840

Toilet brush set wall model,  
complete  
Portaspazzola WC con spazzola  
modello da parete, completo  
Juego de cepillo para WC  
completo, para colocar en la pared



12 660 979 \*

WC actuator  
Piastra di azionamento WC  
Placa de accionamiento de  
inodoro

Aloys F. Dornbracht GmbH & Co. KG Armaturenfabrik  
Köbbingser Mühle 6, D-58640 Iserlohn  
Telefon +49(0)2371 433-0, Fax +49(0)2371 433-232  
mail@dornbracht.de, dornbracht.com

Dornbracht Group  
Premium Solutions for Interior Architecture

